

# Review of Research and Application of Prefabricated and Assembled Concrete Bent Caps

Chengyue Wang, Yin Shen\* and Jiasi Chen

Department of Bridge Engineering, Tongji University, Shanghai 200092, China;  
\* Correspondence: shenyin@tongji.edu.cn

**Abstract:** Prefabricated assembly construction has become a trend in urban bridge construction. However, urban wide bridges with high traffic demand usually have a large number of lower structure bent caps. The length of the bent caps is often greater than 25 m, and the weight is usually more than 300 t. The transportation conditions of the overall prefabricated bent caps are limited by roads, and the overall lifting tonnage is too large. The precast assembly technology of bent caps has been widely valued and developed rapidly. In this paper, the prefabricated assembly technology for bent caps is classified, and typical engineering cases are introduced. The performance research status of prefabricated bent caps is summarized, as are the existing shortcomings and improvement directions of prefabricated bent cap assembly technology.

**Keywords:** Bridge engineering; concrete; bent cap; prefabrication and assembly technology

## 1 Introduction

The bent cap plays the role of connecting the upper and lower parts, and transmits the load of the upper structure to the substructure such as pier column and foundation, which is an important part of the pier. In the industrialized construction of bridge structures, prefabricated technology is increasingly used in bridge design and construction. Prefabricated technology has been widely used in bridge superstructures in China; this technology has greatly improved the quality of components and the efficiency of construction, but the main construction method for substructures is still on-site pouring. However, the bent cap of the traditional cast-in-place scheme results in many problems during construction due to the on-site pouring of concrete and the binding of steel bars.

Prefabricated construction of bent caps occurred in the 1990s. The earliest examples of the overall prefabricated bent cap project are the Baldorioty Bridge in Juan, Puerto Rico in 1992 and the Redfish Bay Bridge built in Texas in 1994. In 2000 and 2002, two two-lane bridges on Ray Hubbard Lake and Belton Lake (Figure 1) adopted the construction scheme of an integral precast bent cap, which reduced the impact on traffic to a very low level, thus showing great technical advantages.



Figure 1 Lake Ray Hubbard Bridge, USA

**Citation:** Wang, C.; Shen, Y.; Chen, J. Review of Research and Application of Prefabricated and Assembled Concrete Bent Caps. *Prestress Technology* 2023, 3, 01-14. <https://doi.org/10.59238/j.pt.2023.03.001>

Received: 21/08/2023

Accepted: 22/11/2023

Published: 25/12/2023

**Publisher's Note:** Prestress technology stays neutral with regard to jurisdictional claims in published maps and institutional affiliations.



**Copyright:** © 2022 by the authors. Submitted for possible open access publication under the terms and conditions of the Creative Commons Attribution (CC BY) license (<https://creativecommons.org/licenses/by/4.0/>).

In 1997, the Reeky Creek Bridge in Florida, USA, was constructed with a two-stage bent cap [1,2]. In 2009, China used the integral prefabricated bent cap in the Qijia Yellow River Bridge (Figure 2).



**Figure 2** Qijia Yellow River Bridge, China

There have been many engineering cases of semi-prefabricated bent caps at home and abroad. The 13 bent caps of the bridge of the Yangtze River Highway Bridge in Wanxian County, China, also adopt the scheme of open channel beam and post-pouring core concrete. The original construction period of 3 months is shortened to 15 days. The Dubai Rail Transit Viaduct in the United Arab Emirates, completed in 2009, divides the shell of the thin-walled concrete bent cap into several segments, and the core concrete is poured after the on-site assembly is completed [3]. In 2012, the Washington State Department of Transportation built a demonstration bridge to verify the feasibility of rapid construction of prefabricated bridge piers, in which the bent cap adopted a two-stage splicing post-pouring belt construction method [4]. The Singapore Dashixi extension project completed in 2017 adopted a three-stage prefabricated bent cap shell mold and a large cantilever T-shaped pier scheme with post-cast concrete [3]. In 2022, the plan of the Shanghai Yangtze River Channel adopted semi-prefabricated and assembled portal bent caps. The prefabricated assembly scheme of prefabricated U-shaped formwork hoisting, post-pouring concrete in the shell and forming combined force is designed to solve the problem that the span of the portal bent caps is too large to realize the prefabricated assembly of the whole bent cap, and segmental prefabrication does not have on-site assembly conditions.

Semi-prefabricated bent cap not only saves the formwork and greatly shortens the construction period but also reduces the construction site and equipment requirements. Therefore, in the past ten years, many new bent cap design and prefabricated assembly construction methods with lightweight materials as the main feature have appeared in China, and these methods have been widely used in practical projects. In this paper, the current prefabrication and assembly technologies for bent caps are classified, and the scope of application is summarized and compared. The engineering cases are introduced. The relevant experimental research and mechanical performance of prefabricated bent caps are reviewed and summarized. The shortcomings of prefabrication and assembly technology for bent caps in practical engineering applications and the problems identified in related research are described. Finally, the research frontier of bent cap prefabrication technology is discussed, and the development direction of the improvement method of bent cap prefabrication technology, such as the application of high-performance materials and the design of new bent cap structures, are explored.

## 2 Bent Cap Precast Assembly Technology Classification

Prefabricated bent caps can be divided into fully prefabricated bent caps and semi-prefabricated bent caps [5], as shown in Figure 3.

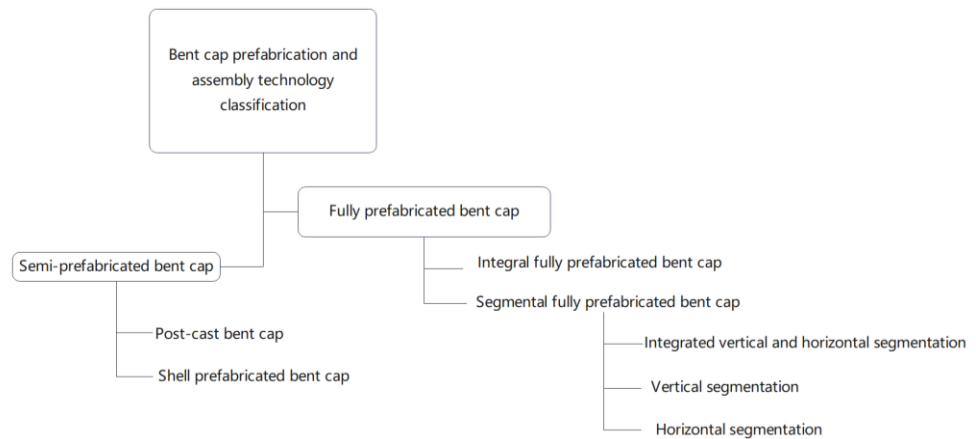

**Figure 3** Bent cap prefabricated assembly technology classification diagram

The fully prefabricated bent cap is divided into overall prefabricated and segmental prefabricated parts, as shown in Figure 4.



(a) Whole prefabricated bent cap

(b) Segmental precast bent cap

**Figure 4** Fully prefabricated bent cap

The overall prefabricated bent cap is the main method for the rapid construction of bridge substructures. However, the overall prefabricated bent cap has a large weight and high requirements for transportation and lifting machinery, which usually causes inconvenience in the construction of bridges in the city. For the construction of small and medium-sized bridges, a whole prefabricated bent cap can be used, but for large-span bent caps, this approach is not suitable for the whole prefabricated cap.

Segmental full prefabrication is to divide the horizontal (or longitudinal) segments (or segments) of the bent cap into several segments for prefabrication. Only splicing joints can be processed to complete on-site assembly, and vertical formwork is no longer needed. According to the segmentation method, it can be divided into transverse segmentation, longitudinal segmentation and comprehensive segmentation.

According to the different treatment methods used for connecting surfaces, transverse cutting and full prefabrication of bent caps can be divided into small key teeth combined assembly, large key teeth combined assembly, steel key combined assembly, and bracket combined assembly. In addition, there are also segmented assemblies that cut the bent cap vertically and stacked assemblies that cut the bent cap vertically and horizontally. However, the splicing joints of fully prefabricated bent

caps are prone to water seepage, which affects durability and imposes high requirements on the construction site, construction level and operation equipment.

For a segmental precast bent cap, the weight of the segment, the working capacity of the lifting machinery, and the overall performance after assembly need to be comprehensively considered. For medium-sized and large projects, the importance coefficient is large, and a structure with less or no segmentation should be adopted as much as possible. However, small-scale projects focus on work efficiency. Under the premise of ensuring quality, simple construction operation and rapid construction have become the goals of interest, and stacking combinations are the most appropriate. Therefore, large-scale projects should adopt horizontal segmentation, small- and medium-sized projects should adopt vertical segmentation, and vertical and horizontal comprehensive segmentation should be applicable only to small-scale projects.

The characteristics of the semi-prefabricated bent cap include that some parts of the bent cap are prefabricated and some parts are cast in place. The different prefabricated structure forms can be divided into two types: post-pouring belt and shell prefabrication, as shown in Figure 5. The post-pouring belt bent cap is divided into several prefabricated segments horizontally, and the steel bars between the segments are connected by binding or welding; then, the formwork is set up to pour the concrete of the connection joints. The prefabricated shell composite bent cap is prefabricated in advance for the bent cap shell, which is used as a non-dismantling formwork for post-pouring concrete, and the internal concrete is poured after the shell is installed.



(a) Post-pouring belt bent cap

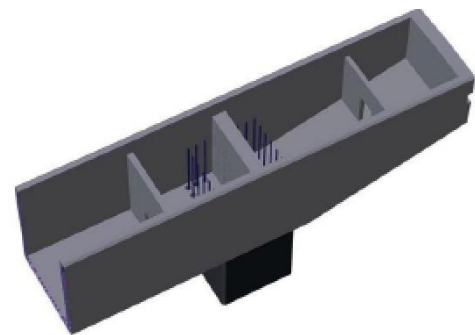

(b) Precast shell composite bent cap

**Figure 5** Semi-prefabricated bent cap

The post-pouring belt bent cap structure is shown in Figure 6, and the post-pouring of the shadow part is completed. Due to the long extension part, the multi-segment assembly method cannot guarantee the unity of the overall performance of the bent cap, and the partial connection section cast-in-place method can effectively reduce the local stress concentration caused by the stage assembly. Moreover, the cast-in-place method has good adaptability, which can compensate for the slight dislocation caused by improper installation.

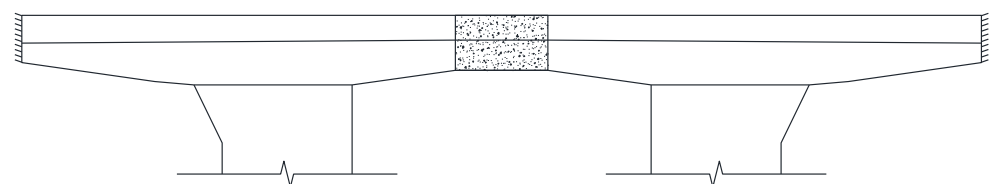

**Figure 6** Diagram of the structure of the post-pouring belt bent cap

The prefabricated shell is constructed by using the prefabricated shell as the formwork for secondary on-site pouring. After the shell is installed, the internal concrete is poured directly, and the bent cap can be quickly constructed.

In the two types of semi-prefabricated bent caps, the post-pouring belt is mainly used in large cantilever bent cap projects, and the joint treatment requirements are greater; moreover, the prefabricated bent cap of the shell is compatible with the advantages of the cast-in-place method and the full prefabricated method. The lifting equipment is not demanding, the integrity is good, and the vertical mold is free. It is easy to realize a connection between the pier column and the bent cap, but the interface between the prefabricated shell and the cast-in-place concrete consists of concrete of different ages. One problem is that debonding caused by inconsistent shrinkage and creep cannot work together [6].

The semi-prefabricated construction method has many advantages over both the cast-in-place method and the fully prefabricated method, which effectively alleviates the influence of unfavorable factors on the construction of bent caps. However, the semi-prefabrication method also has its own disadvantages, which need to be solved by new structures and new thinking in subsequent scientific research and practical engineering.

### 3 Prefabricated assembly bent cap engineering case

In recent years, with the rapid development of urban construction and traffic construction in China, bridge prefabrication and assembly technology has become important for the rapid construction of urban bridges. Prefabricated and assembled bent caps have also been widely used in practical projects.

In 2014, the bent caps of two bridges in the Shanghai S6 highway project were prefabricated and assembled. The total width of the viaduct is 16 m, the section of the bent cap is rectangular, and the prefabricated bent cap and the prefabricated column are connected by a grouting sleeve (Figure 7). The whole prefabricated bent cap is produced in the prefabrication plant. Due to its heavy weight, the lifting and transportation requirements are high. This approach is suitable only for small- and medium-sized bridges. For large-span bent caps, it is not suitable to use the whole prefabricated cap.



**Figure 7** Construction of the bent cap of the Shanghai S6 highway project

In the same year, in the S26 highway project in Shanghai, the total width of the main line viaduct reached 32 m, and a double pier column was used to support the

large cantilever bent cap [7]. The length of the bent cap was 28.5 m, and the distance between the pier columns was 9.4 m. Due to the large volume of the bent cap, to facilitate construction, two sections of the bent cap were prefabricated and assembled, and a 1.5 m cast-in-place belt was set between the sections (Figure 8). Due to the large spacing between the columns, the center of gravity of the prefabricated segment is located within the core distance of the column after hoisting, and the bent cap segment can basically achieve self-balancing, which reduces the difficulty of segment hoisting. However, the design of large pier spacings is not practical for urban viaducts due to increased encroachment on ground road spaces, and such designs are more suitable for bridge design across existing lines.



**Figure 8** S26 Two-section precast bent cap construction

In 2016, in the Jiamin Elevated Road (G2~S6) project, a large cantilever inverted T' bent cap double column pier was used as the main line elevated standard bridge substructure, the column center spacing was 5.2 m, and the bent cap was a prestressed concrete structure. The bent cap is cut along the transverse direction of the bridge and divided into three pieces for prefabrication (Figure 9). The splicing joints between the segments are arranged outside the column to avoid the most unfavorable position of the force at the root of the cantilever arm. The weight of the prefabricated section on the top of the column is approximately 112 t, and the weight of the prefabricated sections of the two outer cantilevers is approximately 84 t. The splicing joint is processed by shear key and binder splicing.

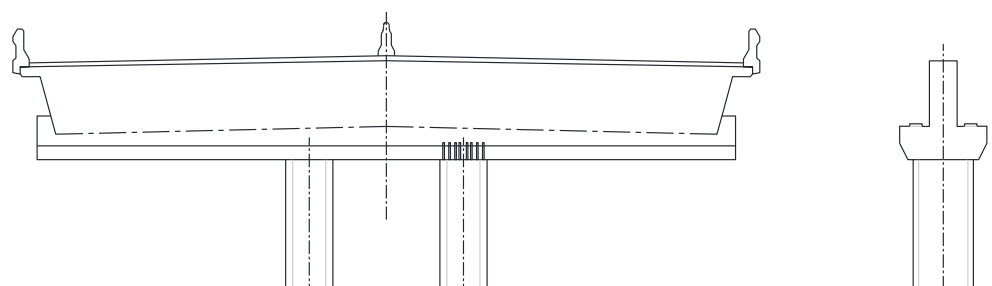

**Figure 9** Structural diagram of three precast bent caps in the Jiamin Viaduct (G2~S6)

In 2017, for the first time, the S7 highway project in Shanghai adopted a segmental precast assembled bent cap with bracket-type joints in China (Figure 10). The upper edge length of the segmental precast bent cap is 19.7 m, the lower edge length is 18.4 m, the height is 3.3 m, and the total weight is nearly 240 t. The precast bent cap is divided into three sections, and the lower edge of the middle section is connected with the pier column in the form of an embedded steel sleeve. The bracket joint has

good shear performance and can effectively improve the shear capacity of the segmental precast bent cap.

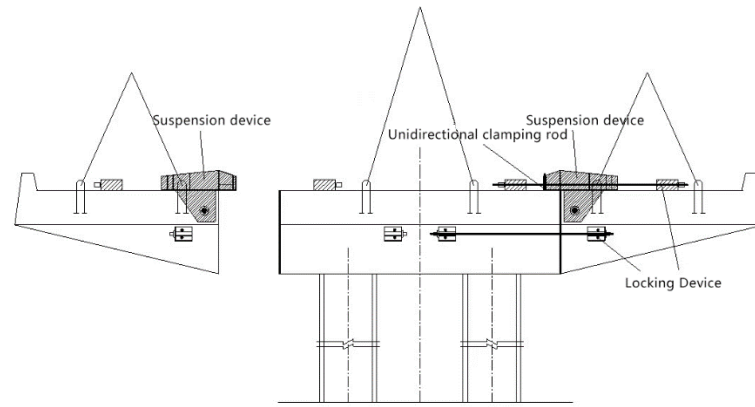

**Figure 10** Construction of a three-section bracket joint bent cap of S7 in Shanghai

In 2018, the large cantilever bent cap of the elevated standard section of the S26-5 main line of the Shanghai Expressway was constructed by the segmental locking method [8] (Figure 11). The bent cap is 23.9 m long and weighs 370 t. It is divided into three segments. The middle section weighs approximately 173 t, and the cantilever sections at both ends weigh approximately 98.5 t. The joint surface is coated with epoxy adhesive with shear keys, and multiple matching protrusions and grooves are used to force the two connection structures to produce a mechanical bite force to bear the shear force. The main vertical force of the cantilever segment is borne and transmitted by the suspension device during the construction of the hanging lock method. The locking device balances the bending moment load generated by the cantilever segment and applies a certain self-balancing horizontal force between the cantilever segment and the middle segment, as shown in Figure 12.

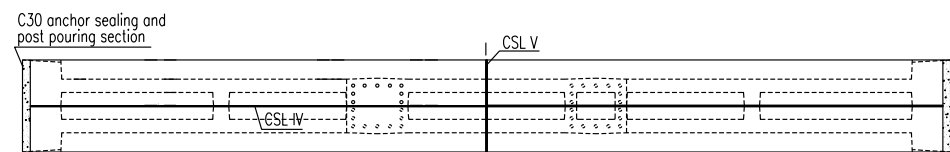

**Figure 11** Construction of the Shanghai S26-5 bent cap hanging lock method

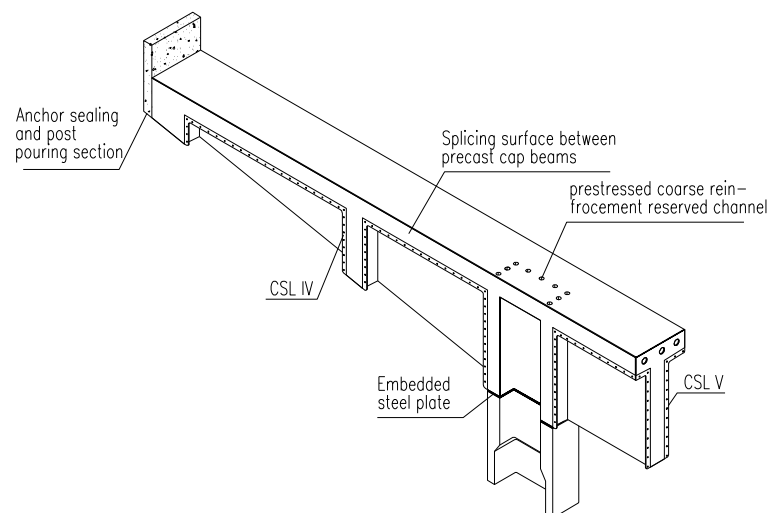

**Figure 12** Lock method assembly construction diagram

In 2021, a prestressed coarse aggregate reactive powder concrete (CA-RPC) bent cap was used in the Nanjing S126 Jiangning section. The overall cross section has a 'π' type structure (Figure 13). The mid-span beam is 2.5 m high, the beam width is 2.4 m, the total length is 24.2 m, and the cantilever length is 8.45 m. The bent cap is prestressed in the roof, and the prestressed steel beams are tensioned at both ends. A single bent cap is composed of four T-shaped prefabricated components divided along the vertical and horizontal centerlines (Figure 14). The single prefabricated component is 11.9 m long and 1.2 m wide. The interface between the prefabricated components of the bent cap is provided with CSL connectors for on-site assembly and installation (Figure 15). The 20 cm baffle range at the end of the bent cap is cast in place, which seals and anchors the internal prestressing tendons.



**Figure 13** S126 Jiangning section bent cap block plane diagram



**Figure 14** Three-dimensional diagram of the S126 Jiangning section 1/4 precast bent cap

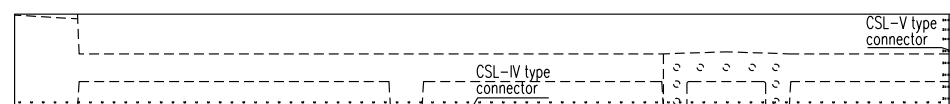

**Figure 15** CSL connector layout



The advantages and disadvantages of the above different types of prefabricated bent cap engineering cases and the comparative evaluation of construction time, mechanical properties and construction difficulty are shown in Table 1 and Table 2.

**Table 1** Advantages and disadvantages of different types of prefabricated cover beam engineering cases

Engineering Case	Type of Bent Cap	Feature (Advantage/Disadvantage)
Shanghai S6 Highway	Integral prefabrication	Convenient and good quality construction/ High requirements of lifting and transportation
Shanghai S26 Highway	Segment prefabrication + post-pouring belt	Reduced the difficulty of segment lifting/ More encroachment on the ground road space
Shanghai Jiamin Viaduct	Key-tooth segment prefabrication	The joint avoids the most unfavorable position of the force/ Large weight of the cantilever arm
Shanghai S7 highway	Corbel-type segmental prefabrication	Good shear resistance
Shanghai S26-5 Expressway	Key-tooth segment prefabrication	Construction by hanging lock method
Nanjing S126 Jiangning section	Segmental prefabrication	Convenient construction and low requirements of lifting and transportation

**Table 2** Comparative evaluation of the construction time, mechanical properties and construction difficulty of different types of prefabricated cover beam engineering cases

Engineering Case	Type of Bent Cap	Construction duration	Mechanical property	The difficulty of construction
Shanghai S6 Highway	Integral prefabrication	A	A	B
Shanghai S26 Highway	Segment prefabrication + post-pouring belt	C	C	B
Shanghai Jiamin Viaduct	Key-tooth segment prefabrication	A	A	B
Shanghai S7 highway	Corbel-type segmental prefabrication	A	B	A
Shanghai S26-5 Expressway	Key-tooth segment prefabrication	A	A	B
Nanjing S126 Jiangning section	Segmental prefabrication	B	C	A

Note: The evaluation is divided into five grades, A-E, from high to low, and the index evaluation grade of the cast-in-place bent cap is set to Grade C. The index evaluation of the two prefabricated assembly methods A and B is better than that of the cast-in-place bent cap, and the index evaluation of the two prefabricated assembly methods D and E is worse than that of the cast-in-place bent cap.

It can be seen from many engineering cases that prefabricated assembled bent caps can not only save formwork and shorten the construction period but also reduce the construction site and equipment requirements, which is in line with the development direction of green and rapid construction.

#### 4 Research on the performance of precast assembled bent caps

##### 4.1 Research status of fully prefabricated bent caps

At home and abroad, the engineering application of fully prefabricated bent cap technology has been very common. The overall prefabricated bent cap has good

homogeneity and compactness, and its compressive strength and durability are high. At present, research on whole precast bent caps has focused mainly on UHPC, RPC and other bent caps with high-performance concrete and thin walls.

c influencing factors are coupled with each other. However, the shear mechanism of precast assembled bent caps still needs to be improved.

#### 4.2 Research status of semiprefabricated bent caps

In the 1980s, several European and American countries used thin-walled steel plates as permanent formwork to make grooves or embossed shapes to increase the bonding performance between permanent formwork and post-cast core concrete. In 1990, the German scholars Hinman and Murray first proposed the idea of using fiber reinforced polymer (FRP) as a permanent formwork. Later, American scholars began to perform much research on the mechanical properties, failure modes and slenderness ratio restrictions of composite columns made of permanent formwork. With the maturity of permanent FRP formwork technology, American engineers built the Black Bridge in Wisconsin in 2007 [19].

In the early 21st century, permanent formwork of semi-prefabricated specimens made of different high-performance composites appeared. In 2005, an Australian company developed the RBS fiber gypsum rapid prototyping formwork [20]. Burler M et al. developed textile reinforced concrete (TRC) [21]. In 2012, S. Verbruggen et al. performed much research on TRC as a permanent formwork and reported that TRC can effectively improve the bearing capacity, ductility and durability of structures.

In 2017, ChulHun Chung [22] of Tan Kok University in South Korea proposed a new type of semi-prefabricated T-shaped bent cap system (Figure 16), which consists of a prefabricated bent cap shell and post-cast concrete. Three specimens were made and tested, including one cast-in-place specimen and two prefabricated specimens with different practices at the longitudinal reinforcement and pier column joints. The test results show that the yield load and ultimate load of the three specimens are almost the same; the cracking load of the prefabricated specimen is approximately 89.5% that of the cast-in-place specimen, but its ductility is better than that of the cast-in-place specimen. In addition, the mechanical properties of the prefabricated specimens are independent of the layout of the longitudinal reinforcement and the connection of the pier column.

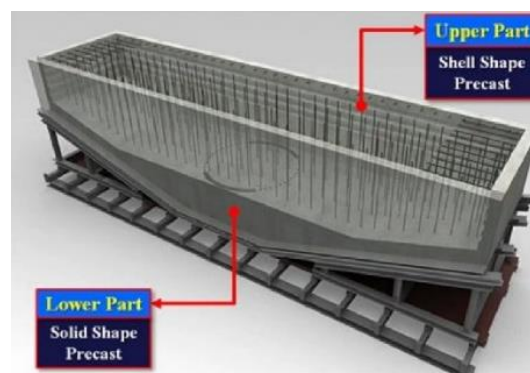

**Figure 16** Prefabricated bent cap shell

Research on semi-prefabricated specimens in China is similar to that in foreign countries. First, concrete thin plates and profiled steel plates are studied and applied in practical engineering. Later, with the development of high-performance composite materials such as FRP, TRC and UHPC, these new materials were also applied to the permanent formwork of semi-prefabricated specimens.

In 2009, Zhang Dachang et al. [23-29] made four semi-precast beams with ordinary concrete as the permanent formwork and compared the flexural performance with that of ordinary reinforced concrete contrast beams. The results showed that the RC beam with prefabricated core cast-in-place conforms to the plane section

assumption. During the test, the interface between the permanent formwork and the post-cast core concrete does not cause damage, such as bond slip, and its failure mode is similar to that of a cast-in-place beam.

In 2014, Lin Yang [30] made a semi-prefabricated beam of UHPC permanent formwork toughened with steel mesh and steel fiber and carried out shear and flexural performance tests. It was found that the semi-prefabricated beam significantly improved the crack resistance load and ultimate bearing capacity, and the relative ductility coefficient also improved compared with that of ordinary cast-in-place reinforced concrete.

In 2015, Wu Xiangguo et al. [31,32] carried out a large-scale flexural and shear test of semi-precast beams with UHPC permanent formwork. The results showed that the UHPC permanent formwork improved the cracking load and ultimate bearing capacity of the semiprecast beams.

In 2017, Zhu [33] conducted an experimental study on the flexural and shear properties of semi-precast beams with ribbed fiber concrete as a permanent formwork. The conclusion is that the interface between the permanent formwork and the post-cast core concrete does not experience bond slip or other damage, the bearing capacity is greater than that of the whole cast beam, and the failure modes of the two beams are similar.

In 2018, Xu [34] completed a flexural performance test of five semi-precast beams with ordinary concrete as the permanent formwork. The research showed that the failure characteristics of semiprecast beams are the same as those of cast-in-place concrete beams. The strain at the interface between the permanent formwork and the post-cast core concrete is relatively smooth, indicating that the two can work together and coordinate the deformation.

The above experimental studies of semi-precast beams at home and abroad show that the mechanical properties of semi-precast beams and cast-in-place beams are relatively consistent. The semi-precast beams composed of permanent formwork made of high-performance composite materials can effectively improve the bearing capacity, durability and ductility of specimens [35-37]. However, experimental research on semi-prefabricated beams at home and abroad has focused mainly on frame beams, and few experimental studies have been conducted on bent caps. The size of the bent cap is much larger than that of the frame beam, and its section strain does not conform to the plane section assumption, so its mechanical performance and failure mode may be quite different.

## 5 Problems and development of bent cap precast assembly technology

### 5.1 The existing problems of bent cap precast assembly technology

By analyzing the engineering application of precast bent caps at home and abroad and researching semi-precast beams and concrete composite beams, it was concluded that the research and application of precast bent caps mainly have the following problems:

- (1) The overall prefabricated bent cap has a large weight and high requirements for lifting and transportation machinery. The segmented precast bent cap is prone to water seepage on the splicing joints, which affects the overall durability.
- (2) Segmental precast bent caps and semi-precast bent caps need to be assembled at the construction site, which has high requirements for the construction site, operation equipment and construction method.
- (3) Current research on semi-prefabricated beams has focused mainly on frame beams, and experimental research on semi-prefabricated bent caps of large-tonnage bridges obviously lags behind engineering applications. The large-tonnage bridge bent cap is large, and its section strain does not conform to the plane section assumption. There is a stress disturbance zone, and its stress mechanism is different from that of the frame beam. At present, research on the mechanical properties and failure modes of prefabricated bent caps is lacking.

- (4) The theoretical analysis of semi-prefabricated beams has been limited to frame beams, and theoretical methods for calculating the normal service limit state and the bearing capacity limit state of semi-prefabricated bent caps are lacking.

#### 5.2 *The improvement direction of bent cap precast assembly technology*

At present, the research directions of prefabricated bent cap assembly technology can be divided into the following categories:

- (1) High-performance concrete, such as UHPC and RPC, is used for precast assembled bent caps. Due to the good mechanical properties and durability of high-performance concrete, the use of new materials can greatly reduce the thickness of the permanent formwork in the semi-prefabricated bent caps and can also greatly reduce the material consumption of fully prefabricated bent caps, thereby reducing the weight and reducing transportation and construction costs. In addition, this approach can also significantly improve the mechanical properties, durability, seismic performance and fire resistance of prefabricated bent caps.
- (2) Explore new prefabricated bent cap structures, such as thin-walled bent caps. By exploring the construction technology of the prefabricated bent cap of the new structure, the strain deformation distribution law under loading, the structural cracking load and the failure load, the oblique section crack resistance and the shear bearing capacity are studied in depth, and the safety and feasibility of the new structure are explored.
- (3) For bridge engineering in high-intensity earthquake-prone areas, improving the seismic design and connection technology of precast assembled bent caps are also the focus of future research.

## 6 Conclusions

In this paper, various prefabricated bent cap methods are classified and analyzed, and the characteristics of different bent cap prefabricated assembly technologies are summarized in combination with engineering examples. The current research on prefabricated bent caps at home and abroad is summarized, and future development directions are proposed.

In future bridge construction, the development requirements of bridge green low-carbon construction will further develop prefabricated assembly technology. In the construction of urban bridges, prefabricated bent caps have great advantages in terms of rapid construction, cost reduction and environmental impact reduction. However, in practical engineering applications, it is also necessary to adjust the local conditions; comprehensively consider factors such as the environment, timeliness, quality and cost; and select appropriate prefabricated assembly methods and construction methods.

**Funding:** National Natural Science Foundation of China project (51778468).

**Conflict of Interest:** All authors disclosed no relevant relationships.

**Data Availability Statement:** The data that support the findings of this study are available from the corresponding author, Shen, upon reasonable request.



## References

1. Seraderian, R.; Culmo, M.P.; et al. Guidelines for Accelerated Bridge Construction Using Precast/Prestressed Concrete Elements Including Guideline Details; PCINER-06-ABC; PCI Northeast Bridge Technical Committee: 2014.

2. P, C.M. *Connection Details for Prefabricated Bridge Elements and Systems*; NO. FHWA-IF-09-010; Federal Highway Administration Research and Technology: Washington, D.C: FHWA, 2009.
3. Sun, M.; Li, J.; Xia, J.; Xia, Z. Trial-design of Semi-prefabricated UHPC Shell Composite Cap Beam. *Journal of Water Resources and Architectural Engineering* **2020**, *18*, 105-110, doi:10.3969/j.issn.1672-1144.2020.04.017.
4. Khaleghi, B.; Schultz, E.; Seguirant, S.; Marsh, L.; Haraldsson, O.; Eberhard, M.; Stanton, J. Accelerated bridge construction in Washington State: From research to practice. *PCI Journal* **2012**, 34-49.
5. Ge, J.; Mei, D.; Yan, X.; Wang, Z. Comparison and Analysis of Construction Method of Precast Pier Cap. *Journal of Technology* **2018**, *18*, 56-62, doi:CNKI:SUN:SHSX.0.2018-01-009.
6. Sun, M. Experimental Study on the Static Mechanical Performance of Semi-prefabricated UHPC Shell Composite Cap Beam. Master, Fuzhou University, Fuzhou, 2023.
7. Xiang, K. Application of Modularization and Industrialization in Construction of S26 Expressway Bridge. *Railway Engineering* **2016**, 26-29, doi:10.3969/j.issn.1003-1995.2016.04.07.
8. KejongYe; Zhao, G.; Shen, Y.; Xu, W. Cantilever Segmental Pier Cap Hang-Locking Construction Method and Application. *Shanghai Highways* **2019**, 40-45, doi:10.3969/j.issn.1007-0109.2019.04.011.
9. Lu, S.; Zheng, W. Calculation Method for Cross-sectional Crack Resistance of Reactive Powder Concrete Beams Reinforced with GFRP Bars. *Journal of Harbin Institute of Technology* **2010**, *42*, 536-540, doi:10.11918/j.issn.0367-6234.2010.04.007.
10. Li, L.; Ye, M.; Hu, F.; Liao, R.; Tang, J.; Shao, X. Experimental Study on The Flexural Behavior of a Prefabricated Large-cantilevered Prestressed UHPC Thinwalled Bent Cap. *China Civil Engineering Journal* **2020**, *53*, 92-104, doi:10.15951/j.tmgcxb.2020.02.008.
11. Voo, Y.L.; Foster, S.J.; Gilbert, R.I. Shear Strength of Fiber Reinforced Reactive Powder Concrete Prestressed Girders without Stirrups. *J Adv Concr Technol* **2006**, *4*, 123-132, doi:10.3151/jact.4.123.
12. Voo, Y.L.; Poon, W.K.; Foster, S.J. Shear Strength of Steel Fiber-Reinforced Ultrahigh-Performance Concrete Beams without Stirrups. *Journal of Structural Engineering* **2010**, *136*, 1393-1400, doi:10.1061/(Asce)St.1943-541x.0000234.
13. Ji, W.; Ding, B.; An, M. Experimental Study on the Shear Capacity of Reactive Powder Concrete T-Beams. *China Railway Science* **2011**, *32*, 38-42, doi:Sun:Zgtk.0.2011-05-008.
14. Xu, H.; Deng, Z.; Chen, C.; Chen, X. Experimental Study on Shear Strength of Ultra-high Performance Fiber Reinforced Concrete Beams. *China Civil Engineering Journal* **2014**, *47*, 91-97, doi:10.15951/j.tmgcxb.2014.12.011.
15. Zheng, H.; Fang, Z.; Liu, M. Experimental Study on Shear Behavior of Prestressed Reactive Powder Concrete Box Girders. *China Civil Engineering Journal* **2015**, *48*, 51-63, doi:10.15951/j.tmgcxb.2015.06.007.
16. Chen, B. Study on the Shear Strength of Prestressed RPC girders. Master, Hunan University, 2007.
17. Zhang, P. Study on Oblique Section Shear-bearing Capacity of RPC Beam Based on Softened Truss Theory. Master, Beijing Jiaotong University, 2011.
18. Xu, H.; Deng, Z. Shear Capacity of Uhpfrc Beams with Stirrups. *Journal of Harbin Institute of Technology* **2015**, *47*, 80-85, doi:10.11918/j.issn.0367-6234.2015.12.014.
19. Bank, L.C.; Oliva, M.G.; Bae, H.U.; Barker, J.W.; Yoo, S.W. Pultruded FRP Plank as Formwork and Reinforcement for Concrete Members. *Adv Struct Eng* **2007**, *10*, 525-535, doi:Doi.10.1260/136943307782417681.
20. Chahrour, A.H.; Soudki, K.A.; Straube, J. RBS Polymer Encased Concrete Wall Part I: Experimental Study and Theoretical Provisions for Flexure and Shear. *Construction and Building Materials* **2005**, *19*, 550-563, doi:10.1016/j.conbuildmat.2004.12.003.
21. Butler, M.; Mechtcherine, V.; Hempel, S. Durability of Textile Reinforced Concrete Made With AR Glass Fibre: Effect of the Matrix Composition. *Mater Struct* **2010**, *43*, 1351-1368, doi:10.1617/s11527-010-9586-8.
22. Chung, C.H.; Lee, J.H.; Kwon, S.H. Proposal of a New Partially Precast Pier Cap System and Experimental Verification of its Structural Performance. *Ksce J Civ Eng* **2018**, *22*, 2362-2370, doi:10.1007/s12205-017-1268-4.
23. Zhang, D.; Zhi, Z.; Lu, Z.; Jin, R.; Liu, Y. Experimental Studies of Bending Capacities of RC Beams with Precast External Shell and Cast-in-place Core Concrete. *Engineering Mechanics* **2009**, *26*, 164-170.
24. Zhang, D.; Zhi, Z.; Lu, Z.; Jin, R. Experimental Studies on Aseismic Performance of Assembly RC Columns with Precast External Shell and Cast-in-place Core Concrete. *Engineering Mechanics* **2009**, *26*, 131-137.
25. Zhi, Z.; Zhang, D.; Lu, Z.; Liu, Y. Manufacturing Method of Precast Core Cast-in-place Assembled Monolithic RC Beam U-shaped Shell. *Journal of Yancheng Institute of Technology (Natural Science Edition)* **2011**, *24*, 66-70, doi:10.3969/j.issn.1671-5322.2011.01.017.
26. Zhi, Z.; Zhang, D.; Lu, Z. Test Study on Bending-resistance of Precast Shell for RC Beam in Fabricated Integral Structure with Precast Shell and Cast-in-place Core Concrete. *Sichuan Building Science* **2010**, *36*, 1-4, doi:10.3969/j.issn.1008-1933.2010.01.001.
27. Zhi, Z.; Zhang, D.; Xun, Y.; Lu, Z. Experimental Studies on Shearing Behavior of Integral Assembly RC Beams with Precast External Shell and Cast-in-place Core Concrete. *Engineering Mechanics* **2012**, *29*, 342-348, doi:10.6052/j.issn.1000-4750.2011.06.0342.
28. Shi, Z.; Zhi, Z. New Assembled RC Structure: Research Status of Shell Precast Core Cast-in-place Assembled Monolithic RC Structure. *Science & Technology Vision* **2013**, 209-210.

29. Zhi, Z.; Zhang, D.; Xun, Y.; Li, Y. Experimental Studies on the Flexural Behavior of Assembled Monolithic RC Columns with Precast External Shell and Cast-in-place Core Concrete. *Industrial Construction* **2012**, *42*, 25-29, doi:10.13204/j.gyz2012.12.033.
30. Lin, Y. Flexural and Shear Behavior of UHPC Composite Beams. Master, Harbin Institute of Technology, 2014.
31. Wu, X.; Lin, Y.; Zhang, X.; Tian, Y.; Jiang, H.; Wang, Z. Experimental Study on the Shear Behaviors of New UHPC-RC Composite Beam. In Proceedings of the Inaugural Meeting of the Ninth Council of Concrete and Cement Products Branch of China Silicate Society and the 11th National Symposium on High Performance Concrete, Harbin, 2015; pp. 36-43.
32. Wu, X.; Zhang, X.; Lin, Y.; Tian, Y.; Jiang, H.; Wang, Z. Experimental Study on the Flexural Behaviors of New UHPC-RC Composite Beam. In Proceedings of the Inaugural Meeting of the Ninth Council of Concrete and Cement Products Branch of China Silicate Society and the 11th National Symposium on High Performance Concrete, Harbin, 2015; pp. 45-50.
33. Zhu, J. Technology Research on Permanent Beam Formwork of Ribbed Fiber Concrete. Master, Suzhou University of Science and Technology, 2017.
34. Xu, C. Study on Mechanical Behavior of Reinforced Concrete Beam with Permanent Formwork. Master, Harbin University of Technology, 2018.
35. Xun, Y.; Tian, G.; Cap, P. Experimental Research on Bending Behavior of Reinforced T-shaped Composite Beams Strengthened with Textile Reinforced Concrete Sheets. *Concrete* **2017**, 120-123, doi:10.3969/j.issn.1002-3550.2017.03.030.
36. Wu, F.; Zuo, R.; Wen, J.; Liu, B.; Zhou, X. Experiment on Bending Performance of Concrete Beam Without Demoulding. *Journal of Architecture and Civil Engineering* **2018**, *35*, 8-15, doi:Sun:Xbjg.0.2018-02-003.
37. Xun, Y.; Xu, Y.; Zhi, Z. Experimental Researches on the Flexural Performance of Textile Reinforced Concrete Permanent Templates and Reinforced Concrete Composite Beams. In Proceedings of the 25th National Conference on Structural Engineering, Baotou, Inner Mongolia, China, 2016; pp. 221-226.

**AUTHOR BIOGRAPHIES**

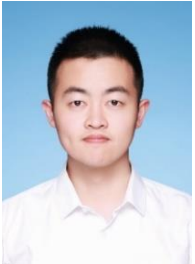
	<p><b>Chengyue Wang</b> M.E. Department of Bridge Engineering, Tongji University. Research Direction: Prestressed Concrete Bridge. Email: 846898486@qq.com</p>		<p><b>Yin Shen</b> D.Eng, Associate Professor. Department of Bridge Engineering, Tongji University. Research Direction: Prestressed Concrete Bridges, Prefabricated and Assembled Bridges and Long-span Bridges. Email: shenyin@tongji.edu.cn</p>
	<p><b>Jiasi Chen</b> M.E. Department of Bridge Engineering, Tongji University. Research Direction: Prestressed Concrete Bridge. Email: 2132483@tongji.edu.cn</p>		