

Scientific Research

Experimental Study on Steel–Concrete Composite Beams Strengthened by Externally Prestressed CFRP Strips

Yin Shen, Xu Jiang, Xuhong Qiang * and Longlong Chen

Department of Construction Engineering, School of Civil Engineering, Tongji University, Shanghai, China;
* Correspondence: qiangxuhong@tongji.edu.cn

Abstract: This paper mainly studies the mechanical properties of simply supported bridges of steel–concrete composite structures strengthened with externally prestressed CFRP plates. The introduction of the prestress of the CFRP plate from the support rods can not only apply prestress to the main beam but also provide an upward lifting force at the bottom end of the main beam to reduce the deflection of the original structure. Therefore, the CFRP board is prestressed by the support rods, which can improve the speed and efficiency of reinforcement construction. The effects of the CFRP amount, prestress size, support rods amount and other parameters on the stiffness and bearing capacity of composite beams were studied by a static test of the scaled model. In the flexural test of the tensioned combination beam, by increasing the prestressing level and the number of CFRP plates, the flexural moment of inertia of the combination beam section was effectively improved, the reinforcement effect on the yield bearing capacity and ultimate flexural bearing capacity of the combination beam was obvious, and the reinforced specimens still had good ductility. For the third combination beam, a CFRP plate with a 15% prestressing level and 3 mm thickness was used for reinforcement. The ultimate load carrying capacity of the combined beam was increased by 47.9%; the yield load of the lower flange was increased by 39.8%; and the stiffness in the elastic phase was increased by 21.66%.

Keywords: tension string reinforcement; CFRP plate; steel–concrete composite beam; active reinforcement method; flexural bearing capacity

Citation: Shen, Y.; Jiang, X.; Qiang, X.; Chen, L. Experimental Study on Steel–Concrete Composite Beams Strengthened by Externally Prestressed CFRP Strips. *Prestress Technology* 2023, 1, 39–52. <https://doi.org/10.59238/j.pt.2023.01.004>

Received: 10/03/2023

Accepted: 07/04/2023

Published: 25/04/2023

Publisher's Note: Prestress technology stays neutral with regard to jurisdictional claims in published maps and institutional affiliations.



Copyright: © 2022 by the authors. Submitted for possible open access publication under the terms and conditions of the Creative Commons Attribution (CC BY) license (<https://creativecommons.org/licenses/by/4.0/>).

1. Introduction

1.1. Development background and existing problems of steel–concrete composite girder bridges

The steel–concrete composite structure can give full play to the characteristics of concrete and steel and is a sustainable form of bridge structure [1]. Due to the advantages of small building height, short construction period and high degree of industrialization [2], steel–concrete composite beams have been widely used in highway and urban bridge construction.

At present, steel-composite girders are most commonly used in the superstructure of highway approach bridges and urban overpasses. Compared with concrete bridges, steel-mixed combination structure bridges are lighter in weight and better in durability and have the advantages of small building height, short construction period and high industrialization; compared with steel bridges, combination structure bridges have the advantages of greater stiffness and less noise. Meanwhile, it uses less steel, has better stability, and has better anti-seismic performance.

Steel–concrete composite girder bridges constructed in the early days had some problems during their use. On the one hand, with the increase of service life, steel–concrete composite beams have various structural damage and quality problems, which affect their bearing capacity; on the other hand, with the increase of traffic loads, if there are defects in the early design, it will lead to an insufficient overall bearing capacity [3].

1.2. Application of CFRP material in bridge repair

There are two main types of reinforcement when CFRP (carbon fiber reinforced polymer) is used in bridge structure reinforcement: the passive reinforcement method and the active reinforcement method. The passive reinforcement method has the disadvantages of not reducing the deformation of the original structure and being unable to close the cracks in the original structure [4]. The active reinforcement method is represented by applying prestress to the CFRP material, which generates prestress in the bridge structure and redistributes the internal force of the original structure, which can effectively overcome the defects of the passive reinforcement method [5].

Carbon fiber sheets (laminate) are mainly divided into two kinds: plates and cloths [6]. In contrast, carbon fiber plate has more advantages than carbon fiber cloth in terms of mechanical properties and construction convenience [7]. However, the current application of carbon fiber board still lags behind that of carbon fiber cloth. The traditional tensile prestressed CFRP reinforcement method has a limited reduction in the midspan deflection of simply supported beams [8]. E. Ghafoori proposed a method of reinforcing steel beams with tensioned prestressed CFRP plates [9], which can effectively reduce the deflection of the original structure without the need for surface pretreatment at the bottom of the steel beams. The tensioned unbonded prestressing system not only actively applies in vitro prestressing to the beam but also effectively improves the stiffness of the structure by means of jacking support rods and saves space by eliminating the need to leave extra space at the ends of the steel beam for CFRP tensioning. It is very worthy of reference in the reinforcement of steel-concrete composite beams. At present, the use and research about steel-concrete composite beams in China are still in its infancy, and it is necessary to conduct in-depth research on steel-concrete composite beams reinforced with prestressed carbon fiber plates.

1.3. Experiments on CFRP passive and active reinforcement

Due to the early use of steel in the engineering world in Europe and the United States, steel bridges have become very common in foreign countries; thus, many foreign scholars have performed many experiments and studies on prestressed CFRP plate reinforcement of steel girders.

E. Ghafoori presented the experimental and theoretical research results of non-prestressed and prestressed bonded CFRP plate strengthening of notched simply supported steel girders, focusing on the effect of CFRP plate debonding on fatigue crack extension. The test results showed that the fatigue life of steel beams strengthened with prestressed CFRP plates was more than five times that of those strengthened with non-prestressed CFRP plates.

Ardalan Hosseini et al. developed an unbonded prestressed CFRP plate strengthening system for simply supported steel beams, and the experimental results showed that the effective load carrying capacity of the PBR (prestressed bond repair) system before debonding failure of the CFRP plate was much lower than that of the PUR (prestressed unbonded repair) system.

N. Ragab, R. El-Hacha and M. Aly summarized the analytical studies, experimental studies, demonstration projects and field applications of non-prestressed and prestressed FRP materials for strengthening steel structures and concluded that non-prestressed FRPs can increase ultimate loads and reduce deflections. By applying prestressing to FRP, the material can be used more effectively, and the stiffness of the member can be enhanced. The yield load after reinforcement is significantly higher than that of non-prestressed reinforced members, and the final load capacity can be further increased. Prestressed FRP increases the stiffness under service load while maintaining the ductility of the beam. When using high elastomeric modulus FRP, the prestressing reduces the overload damage due to overload.

Numerous tests and studies have shown that CFRP plate reinforcement with prestressing is significantly better than CFRP plate reinforcement without prestressing. The prestressed CFRP plate reinforcement has a significant effect on improving

the structural stiffness, yield bearing capacity, and ultimate bearing capacity and reducing the deflection in the span of simply supported beams. The CFRP plate as a high strength material, combined with prestressing, can play an active reinforcement effect and give full play to its advantages of high tensile strength.

2. Test plan

2.1. Specimen Design

A total of 4 I-shaped steel–concrete composite simply supported beam scale specimens were designed in this test. The net span of the simply supported composite beam is 5000 mm. The support method is simple support. The number and location of the strain gauges and the construction of the composite beam are shown in Figure 1.

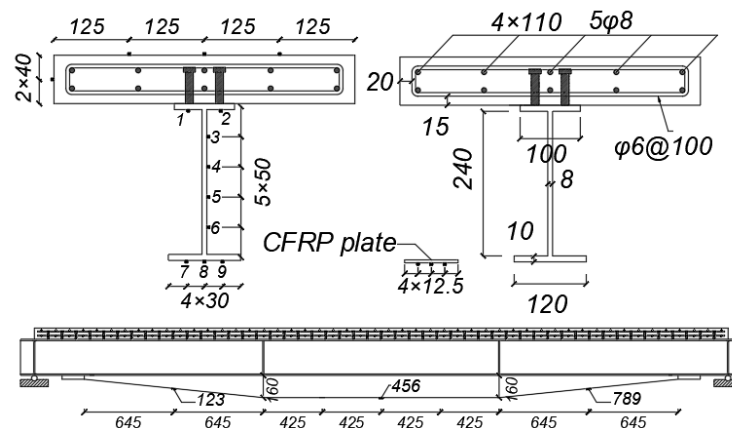

Figure 1. Sectional structure (unit: mm)

2.2. Specimen Reinforcement Scheme

The specimen was reinforced on the lower surface of the steel beam by means of a string-type CFRP plate. The spacing between the support rods is 1700 mm, and the spacing between the loading points is also 1700 mm.

The reinforcement scheme is shown in Table 1:

Table 1. Reinforcement plan

Specimen number	Width of CFRP / mm	Thickness of CFRP / mm	Prestress level / %
S1	/	/	/
S2	50	2	10
S3	50	3	10
S4	50	3	15

In Table 1, the prestress level refers to the percentage value of internal stress (σ) and tensile strength in the CFRP plates (2520 MPa).

2.3. Test device and loading scheme

The loading method of this test is force-controlled static loading. The static test loading device adopts a static hydraulic loading system, a jack generates a concentrated force P , and the force is transmitted to the two loading points on the specimen through the load distribution beam.

The load classification for formal loading is 20 kN. When the specimen is close to yield or near failure (the upper surface of the concrete is crushed or the CFRP

plates fail), the load classification is changed to 10 kN. Each level of load is held for 5~10 min to read data and observe phenomena.

3. Test process and stress phenomenon

3.1. Prestress application and prestress loss measurement of tensioned CFRP plates

3.1.1. Tensioned CFRP plate prestressing

After all strain gauge channels and displacement gauge channels are set up, prestress is applied. First, use a jack to raise the strain in the CFRP plate to approximately reach the target value, and then use a wrench to tighten the nut for fine-tuning. The prestress level is controlled by the CFRP plate strain. The prestressing process is shown in Figure 2.

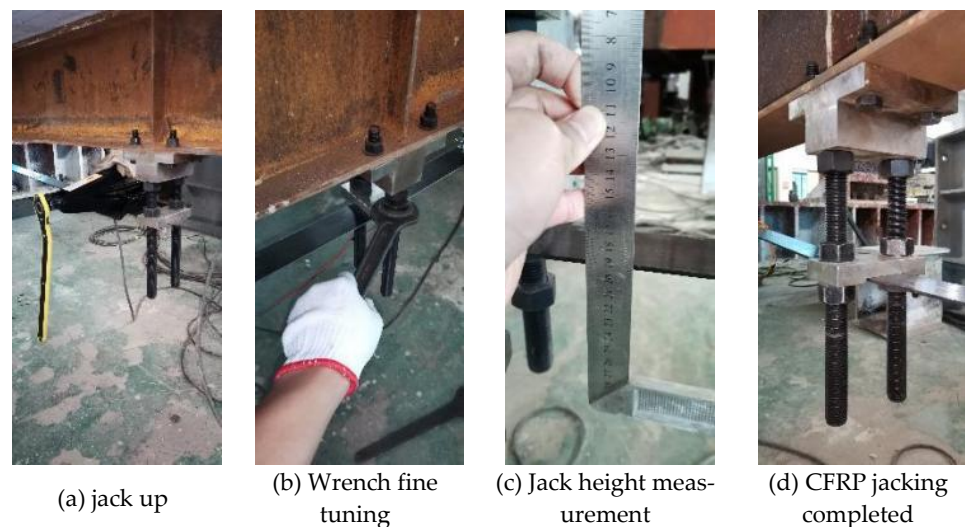

Figure 2. Prestressing process

Since the strain in the CFRP plate will be lost to a certain extent when the jack is unloaded, the height of the jack needs to be slightly higher than the theoretical value. After unloading, the wrench is used to fine-tune the nut to accurately control the prestress level to reach the target value and make the heights of the four support rods equal.

3.1.2. Prestress loss measurement

After the prestressing was completed, the loss of the tensioned CFRP plate reinforcement system was measured. The prestress loss measurements were performed on the third beam and the fourth beam. The relaxation measurement time for the third beam was 6 days. The relaxation measurement time for the fourth beam was 5 days. During the 6 days of prestress level monitoring, the prestress level had no tendency to continue to decrease after the initial small drop, and its value remained stable, so there was no need to continue monitoring. A representative strain loss curve is shown in Figure 3.

According to the prestress loss curve, the decrease of the CFRP plate strain gradually slows down with time, becomes stable in the later stage, and there is no further downward trend. The average strain loss of the CFRP plate at each measuring point is 2.58%.

According to the relaxation measurement results, the strut jacking method can apply stable prestress to the tension string CFRP plate, and the prestressing method of the tension string CFRP plate reinforcement system is feasible.

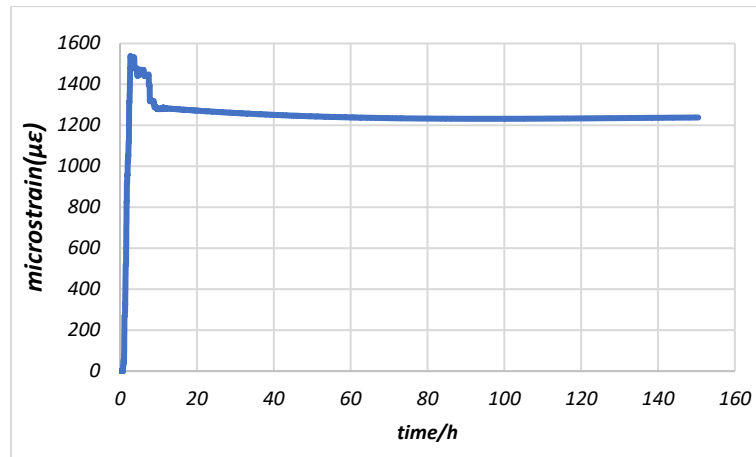

Figure 3. Strain relaxation curve

3.2. Loading Process and Test Phenomenon

Gradual loading was performed according to the test protocol, and the loading was stopped when the CFRP plate was torn or the upper surface of the concrete was crushed. The specimen has no bearing capacity at the last load level, so the load of the previous stage of the final failure load is taken as the ultimate bearing capacity of the specimen.

3.2.1. Test phenomenon and failure states of the reference beam (S1)

In the initial stage of loading, the strain at each point in the concrete and the steel beam increases linearly. The strain of the concrete and its internal steel bars are all negative, and the entire section of the concrete is in a state of compression.



Figure 4. The crush state of the concrete of the reference beam

When the load reaches 200 kN, the lower flange of the steel beam yields, and the deflection of the composite beam increases rapidly. When the load reaches 340 kN, the crackling sound of concrete crushing becomes louder, the bearing capacity of the specimen is already unstable, and the mid-span deflection increases sharply. When the load reaches 350 kN, the mid-span section of the concrete slab is crushed and damaged, and block-shaped staggered warping occurs, as shown in Figure 4. The final bearing capacity is 340 kN.

3.2.2. Test phenomenon and failure state of the second beam (S2)

The support rods height of the second composite beam are 168 mm. When the load reaches 220 kN, the lower flange of the steel beam yields, and the deflection of

the composite beam increases rapidly. When the load reaches 440 kN, the CFRP plate emits the sound of fiber tearing, and the mid-span deflection increases sharply. When the load reaches approximately 450 kN, the surface of the concrete slab is crushed and damaged, and a transverse crack occurs through the upper edge of the concrete slab at the mid-span, as shown in Figure 5. The entire reinforcement system fails. The fractured anchoring end of the CFRP plate is in the form of scattered filaments, as shown in Figure 6. The final bearing capacity is 447 kN.



Figure 5. Surface cracks on concrete slab of second beam

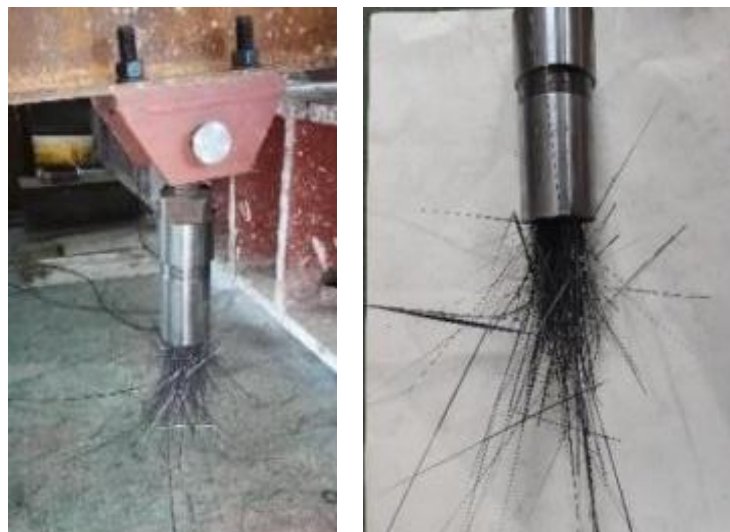

Figure 6. The fracture state of the CFRP plate at the anchoring end

The CFRP plate and the upper edge of the concrete slab were almost destroyed at the same time. When the CFRP plate broke, the failure of the upper edge of the concrete was not serious, but it was close to failure. The failure of the tension string reinforcement system is almost identical to the failure of the concrete slab, and this failure mode is an ideal failure mode.

3.2.3. Test phenomenon and failure state of the third beam (S3)

The support rods height of the third beam are 168 mm, which is almost the same as that of the second beam. When the load reaches 240 kN, the lower flange of the steel beam yields. When the load reached 420 kN, a local fracture occurred at one of the anchorage ends, and a carbon fiber strip with a width of approximately 8 mm fell. When the load reaches approximately 450 kN, the CFRP board completely breaks and fails, as shown in Figure 7(a)(b). The concrete slab was damaged immediately

afterward, and block-like crushing and warping appeared on the right side of the left loading point of the upper edge of the concrete, as shown in Figure 8. The final bearing capacity is 438 kN.

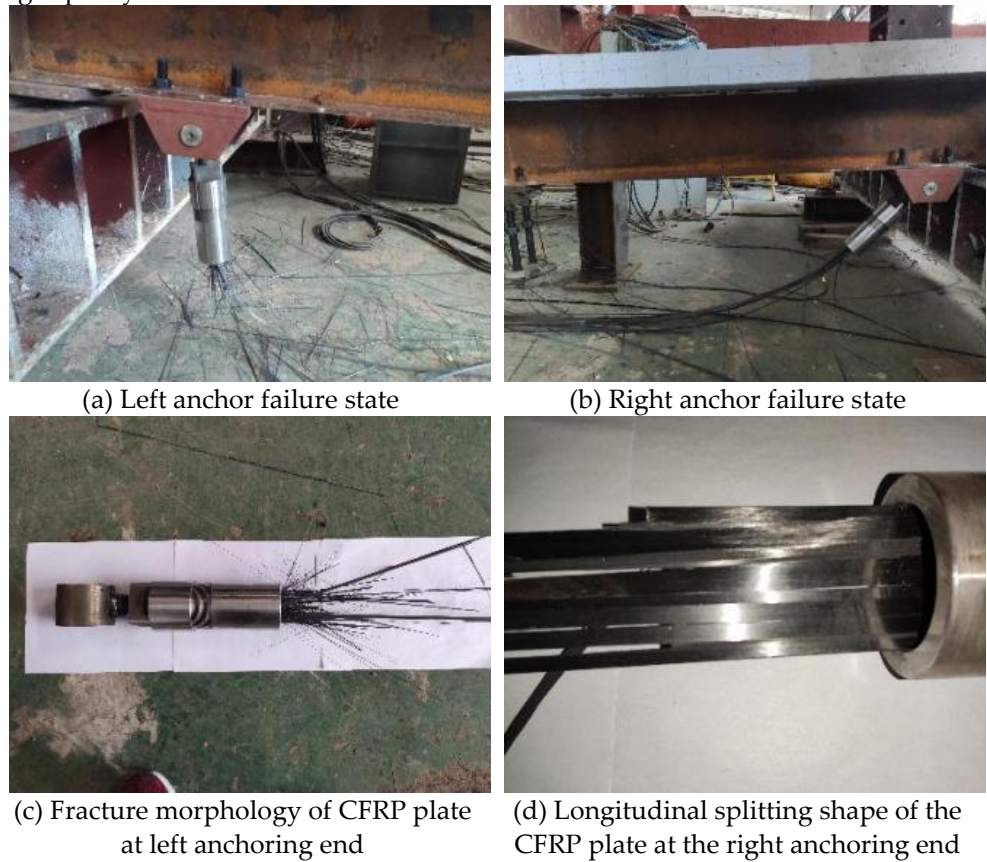

Figure 7. Destruction state of CFRP plates

After the CFRP plate is broken at the left anchoring end, the fibers of the CFRP plate are burst-like, as shown in Figure 7(c). The remaining CFRP plate was split longitudinally and dropped from the right anchoring end to the ground, as shown in Figure 7(d).



Figure 8. Concrete slab failure form of the third beam

The failure of the third composite beam is due to the premature fracture of the CFRP plate due to the incompatibility of the anchor clips, which led to the partial crushing of the CFRP plate during preload. When the CFRP plate breaks, the concrete plate has not yet failed. This failure mode is not an ideal failure mode.

3.2.4. Test phenomenon and failure state of the fourth beam (S4)

The height of the fourth beam support rods is 186 mm. When the load reaches 270 kN, the lower flange of the steel beam yields. When the load reaches approximately 470 kN, the CFRP plate emits a slight hissing sound. When the load reaches 490 kN, the sound of fiber tearing in the CFRP plate is more frequent, and the growth of mid-span deflection is accelerated. When the load reaches 500 kN, a local bulge occurs on one side of the upper surface of the concrete slab, which means the local failure of the concrete slab. When the load reaches 510 kN, the concrete slab is compressively damaged in the mid-span full section, and the concrete blocks in the mid-span are staggered and bulged, as shown in Figure 9.

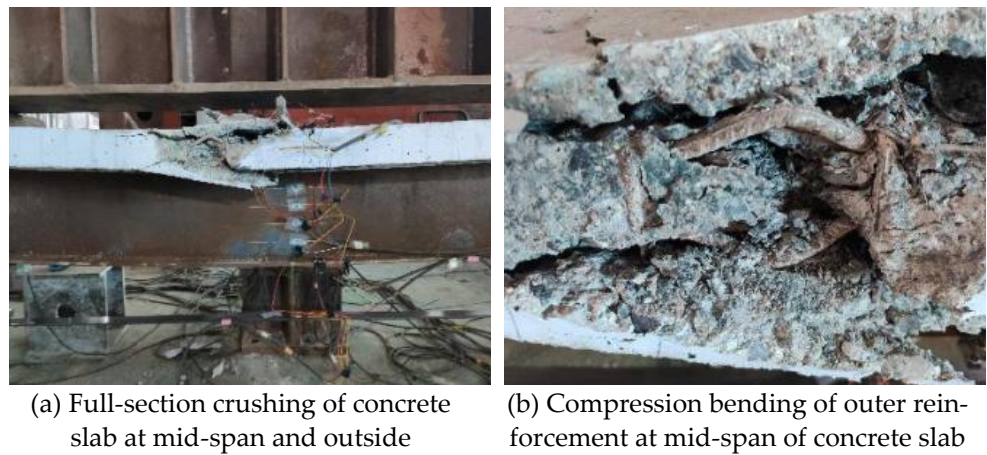

Figure 9. Concrete slab failure form of the fourth beam

The CFRP plate was then torn and split continuously at the two anchorage clamping ends and the turning block position, making continuous loud noises, and the main form of failure was the longitudinal tear of carbon fiber, as shown in Figure 10. The entire reinforcement system failed. The final bearing capacity is 503 kN.

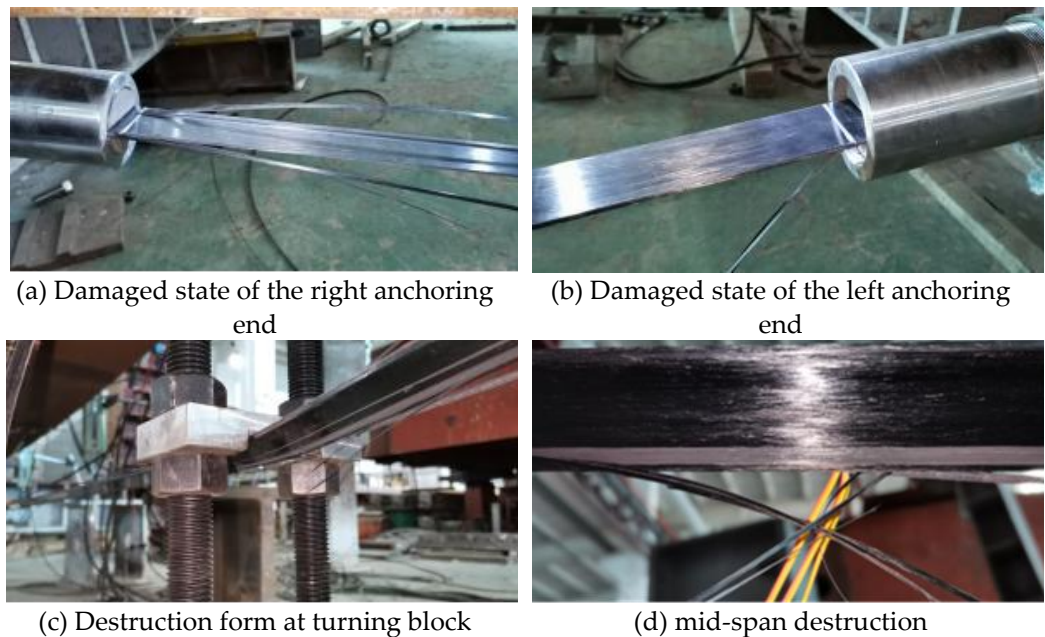

Figure 10. The failure state of the CFRP plate of the fourth beam

The failure mode of the fourth composite beam is the mid-span collapse of the concrete slab. After the failure of the concrete slab, the CFRP plate is destroyed. This is the ideal mode of destruction.

4. Test results and reinforcement effect analysis

4.1. Load-strain curve of steel beam

The load-strain curves of the upper flange, web and lower flange of the steel beam are shown in Figure 11. The figure shows that the stiffness, yield load and ultimate bearing capacity of the composite beam can be effectively improved by increasing the cross-sectional area of the CFRP plate and increasing the prestress level. As a result, the strain in the upper flange, lower flange and web under the same load level is significantly reduced.

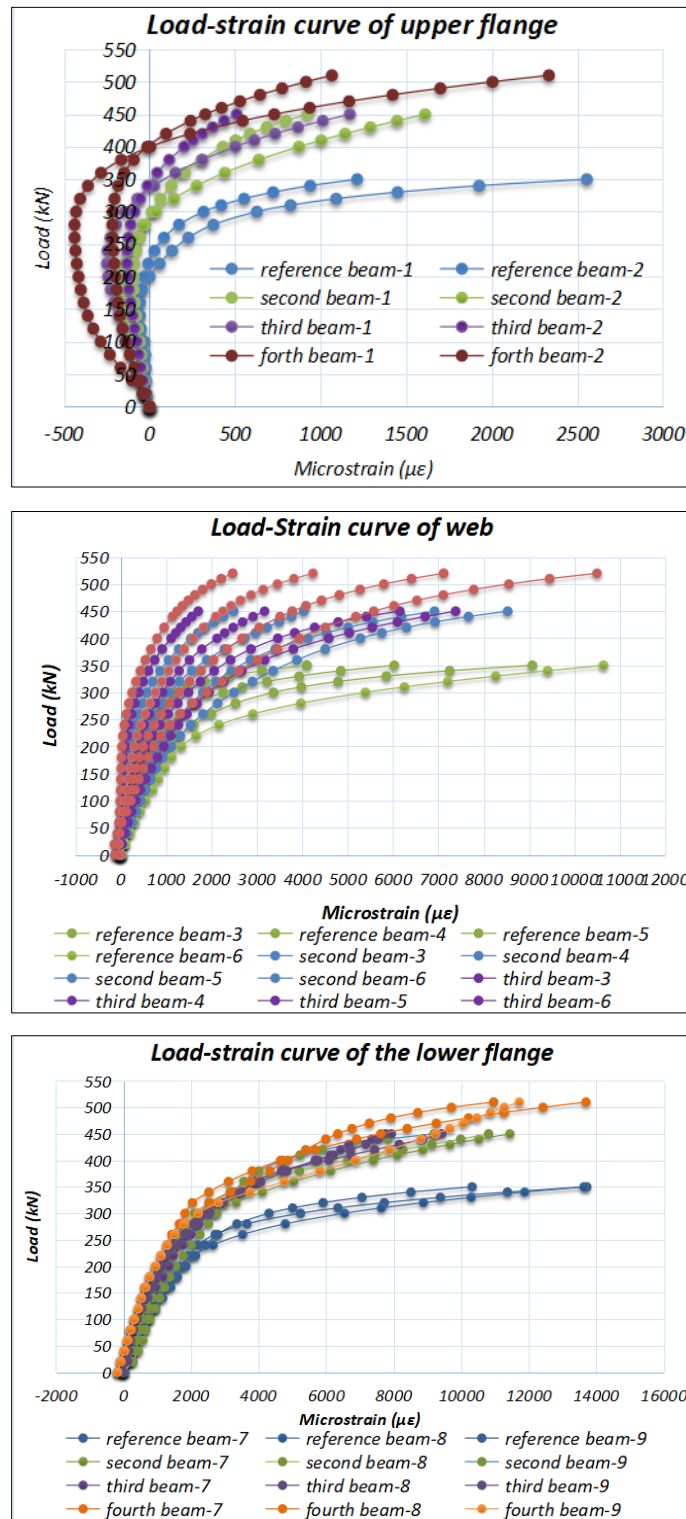

Figure 11. Strain in upper flange, web and lower flange of steel beam

4.2. Load-strain curve of the CFRP plate

Figure 12 shows the variation curve of the CFRP plate’s strain under load in each working condition.

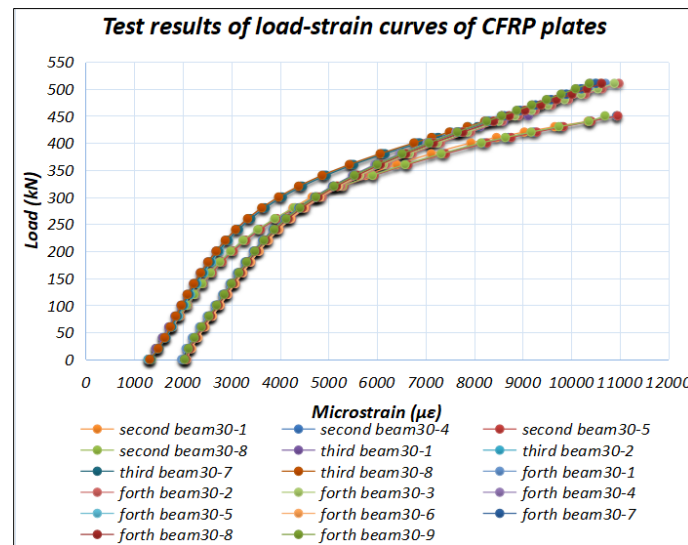

Figure 12. Load-strain curves of CFRP plates

Although the CFRP plate itself is a linear elastic material, the CFRP plate and the composite beam should conform to the deformation coordination, so the trends of the CFRP plate load-strain curve and the mid-span load–deflection curve are similar. The ultimate tensile stress and tensile strength utilization are shown in Table 2. As seen from the table, the premature failure of the CFRP plate of the third beam resulted in a strength utilization rate of only 65.11%. Both the second beam and the fourth beam have more than 80% strength utilization of CFRP panels.

Table 2. Strain increment and material tensile strength utilization of CFRP plate

Specimen number	Initial strain / $\mu\epsilon$	Final strain / $\mu\epsilon$	Ultimate tensile stress / MPa	Tensile strength utilization rate / %
S2	1300	10495	2047	81.18
S3	1316	8418	1642	65.11
S4	1958	10821	2110	83.70

From the test phenomenon, the damage of the CFRP plate reinforced by the tension string mostly occurs at the clamping end of the anchor and the position of the steering block, and the CFRP plate is prone to stress concentration at these two positions. By selecting suitable anchor clips, increasing the contact area between the steering block and the CFRP plate, and avoiding sharp turning of the CFRP plate at the turning point, stress concentration can be avoided, and the strength utilization rate of the CFRP plate can be improved.

4.3. Mid-span load–displacement curve of the composite beam

The mid-span deflection curves of the four test beams are shown in Fig. 13.

As shown in Figure 13, except for the third test beam, which was damaged due to the premature failure of the CFRP plate, the ultimate deflections of the remaining three test beams are basically the same, which are 113.65 mm, 112.69 mm and 116 mm.

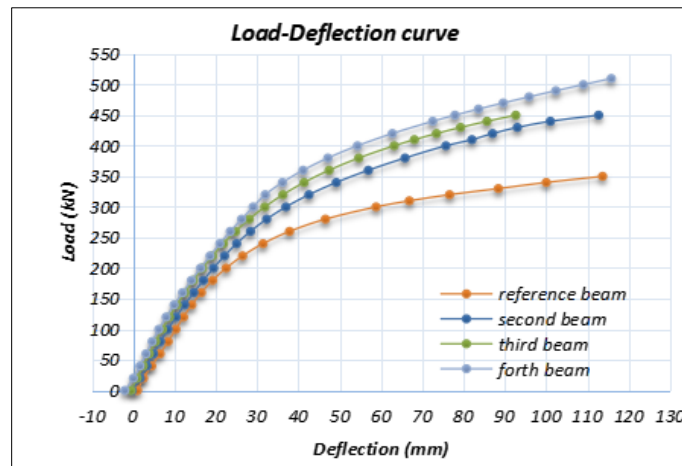

Figure 13. Load–displacement curve at mid-span of composite beam

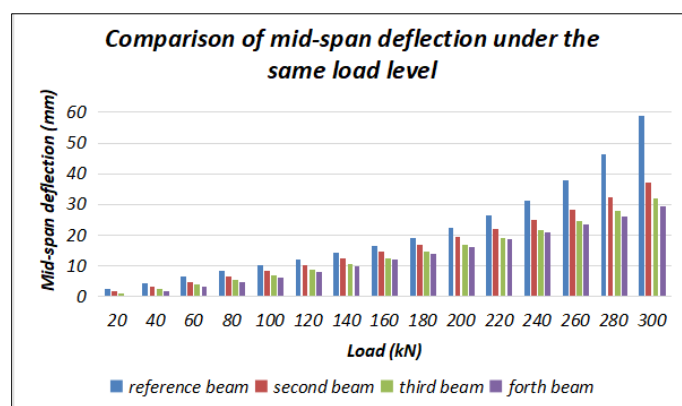

Figure 14. Mid-span deflection at the same load level

The reinforcement of the CFRP plate significantly improves the stiffness and ultimate bearing capacity of the composite beam. In addition, due to the delay of yield, the mid-span deflection of the composite beam under the same load level is significantly reduced, as shown in Figure 14.

4.4. Analysis of the flexural bearing capacity of the specimens

The improvement effect of the yield bearing capacity of the specimens is shown in Table 3. By comparing the second beam and the reference beam, it can be seen that the CFRP plate reinforcement increases the yield bearing capacity of the composite beam by approximately 30 kN, and the effect is obvious. By comparing the second beam, the third beam and the fourth beam, it can be seen that an increase in the thickness and prestress level of the CFRP plate can lead to an improvement in the yield bearing capacity. The yield load is increased by approximately 40% in the last set.

Table 3. The improvement effect of yield bearing capacity

Specimen number	Yield load test value (kN)	Increase rate (%)	Mid-span deflection at yield (mm)
S1	196	/	19.69
S2	224	14.3	22.56
S3	243	24.0	22.07
S4	274	39.8	23.72

The improvement effect of the ultimate bearing capacity of the specimen is shown in Table 4. Except for the poor reinforcement effect of the carbon plate of the third beam due to premature failure, the rest of the test beams have received good

reinforcement effects. Among them, the bearing capacity of the fourth test beam was increased by nearly 50%.

Table 4. The improvement effect of ultimate bearing capacity

Specimen number	Ultimate bearing capacity test value (kN)	Increase rate (%)	Mid-span deflection at ultimate state (mm)
S1	340	/	114.64
S2	447	31.5	114.16
S3	438	28.8	86.74
S4	503	47.9	112.79

For the prestressed carbon fiber board, whether it is reinforced by gluing or tension string reinforcement, it has a good inhibitory effect on the tensile strain of the lower flange of the steel beam. However, unlike the former, the center of mass of the string-pulling carbon fiber plate is farther from the neutral axis. Therefore, the increase of the number of carbon fiber plate is more obvious for the improvement of the bending moment of inertia of the composite beam section, so the yield bearing capacity and ultimate bearing capacity are improved more obviously.

5. The imitations and challenges of current reinforcement methods and potential areas for future research and improvement

Although the research in this paper has achieved initial success, there is still a long way to go, and there is still much research work to be carried out in further depth:

- (1). The high prestress level of the tensioned CFRP plate reinforcement method will make the strength of the CFRP plate be consumed too much when prestress is applied, which makes the CFRP plate fracture prematurely and cannot obtain the ideal damage mode. Therefore, it is necessary to study how to apply higher prestress in CFRP plates, such as using a larger cross-sectional area of CFRP plates to obtain a higher prestress magnitude under the same actual stress value (i.e., prestress level) in the plate.
- (2). The main limitation of the strength utilization of CFRP plates in the reinforcement method of tensioned CFRP plates comes from the premature failure of the anchorage end. Further research is needed to optimize the anchorage device and steering block of the tensioned string reinforcement system to reduce the stress concentration of the CFRP plate.
- (3). The tensioned CFRP plate reinforcement system proposed in this paper is mainly for small- and medium-span (30~50 m) steel-mixed composite beams. If this system is applied to larger span composite beams, the overall instability problem may be caused by the corresponding small height-to-span ratio of the beams. Further research is needed. On the other hand, the test beam in this paper has been deliberately treated to prevent local instability at the loading point of the steel beam, but in actual engineering reinforcement, due to the direct action of the strut pair on the lower flange, the steel beam may produce local instability, which still needs further research to solve.
- (4). The prestressing tendons of the tensioned string reinforcement system have a large eccentricity, which will consume part of the under-bridge headroom in the actual reinforcement, which is a disadvantage of this reinforcement system, so its application scope will be limited. In the future work, further research is needed to make the tensioned string reinforcement system not affect or less affect the under-bridge headroom, such as adjusting the position of the anchorage end and steering point of the prestressing tendons.
- (5). The installation of the jacking support rod system in this paper requires the drilling of holes in the steel girders to install the bolts, so the application in closed-ended steel sections will be limited. In future work, further research is needed

on how to use this system on closed-ended section beams, for example, optimizing the strut system by changing the original use of bolted struts to triangular stabilized struts that rely on welded fixation or using the Overman holes inside the closed-ended steel box beam to perform collaborative installation operations inside and outside the strut.

6. Conclusion

- (1). For small- and medium-span (30 m~50 m) steel-hybrid composite beams, a prestressing tensioned CFRP plate reinforcement method without paste and pretreatment of the bottom of the composite beam is proposed, and a prestressing application method without tensioning is designed, which greatly saves space at both ends of the reinforcement system and increases the utilization of the longitudinal space for the bottom of the beam.
- (2). By increasing the prestressing level and the number of CFRP plates, the bending moment of inertia of the cross-section of the composite beam is effectively increased, and the reinforcement effect on the yielding load capacity and ultimate bending load capacity of the composite beam is obvious. By applying prestress by jacking support rods, the eccentricity of the CFRP plate can be effectively used to improve its repair effect, and the reinforced specimen still has good ductility.
- (3). Using ABAQUS finite element software, the influence law of different reinforcement parameters (CFRP plate thickness, CFRP plate width, height of support rods and prestressing level, etc.) on the stress performance and reinforcement effect of the combined beam was investigated, and the best reinforcement solution was selected. For this tensioning CFRP plate reinforcement system, the use of a prestressing level that is too high is unfavorable to the repair effect. On the one hand, the CFRP plate will reduce the tensile reserve of the CFRP plates; on the other hand, a higher prestressing level requires a higher support rod, which will affect the clearance under the bridge.
- (4). The following conclusions were obtained from the static test study: the ultimate load carrying capacity of the steel-hybrid composite girder was increased by 31.5% for the CFRP plate with 10% prestress level and 2 mm thickness, the load at yield of the lower flange of the I-beam was increased by 14.3%, and the stiffness in the elastic phase was increased by 13.09%; the CFRP plate with 10% prestress level and 3 mm thickness increased the stiffness in the elastic phase of the steel-hybrid composite girder by 20.42%. The CFRP plate with a prestressing level of 15% and a thickness of 3 mm increased the ultimate load capacity of the steel-blend composite beam by 47.9%, the load at yield of the lower flange of the I-beam by 39.8%, and the stiffness at the elastic stage by 21.66%. Excluding the test beam RB-2 with premature failure of CFRP plates, the ultimate mid-span deflections of the remaining three test beams UB-0, RB-1 and RB-3 were 113.65 mm, 112.69 mm and 116 mm, respectively, and the ductility coefficients were 5.82, 5.06 and 4.76, respectively.
- (5). The anchorage system of the tensioned CFRP plate reinforcement system was proved to be effective in the long term by relaxation tests, and the stress loss rate in the CFRP plate did not exceed 3%, and the prestress level gradually stabilized over time. The test shows that the internal stresses in each CFRP plate section of this reinforcement method are basically the same, which proves that this reinforcement method has the advantage of low friction loss.
- (6). Three methods were used to calculate the deflection development law of the reinforced steel-hybrid composite beam in the elastic phase: method 1, which approximates the reinforced steel-hybrid composite beam as an equal-section beam and calculates it by the integral method, is in good agreement with the deflection obtained by the finite element method and the experimental method; method 2, which is based on the flexible method, is based on the theory of

calculating the flexible method proposed by F. Kianmofrad and E. Ghafoori in their literature, and the deflection in the elastic phase and the stress in the CFRP plate are calculated by combining the cross-sectional characteristics of the steel-cement composite beam, which are in good agreement with both the experimental and finite element values; and method 3 is based on the formula for calculating the deflection in the span of the composite beam reinforced with extracorporeal prestressing tendons proposed in the Code for the Design of Steel-Concrete Composite Bridges (GB 50917-2013). The calculation formula achieves an error of less than 1% for the elastic phase deflection.

- (7). The theoretical calculation method of the flexural load capacity of the span section of the reinforced composite beam is given based on the characteristics of the cross-sectional forces in the limit state, which can be in good agreement with the finite element values and the test values.
- (8). Based on the curvature development characteristics of the combined beam in the limit state, the theoretical calculation method is given to predict the deflection in the span of the combined beam in the limit state, which can be in good agreement with the finite element and test values.

References

1. Xiao, L.; Wei, X.; Wen, Z.; Li, G. State-of-the-Art Review of Steel-Concrete Composite Bridges in 2019. *Journal of Civil and Environmental Engineering* **2020**, *42*, 168-182.
2. Huang, Q. Design Principles of Steel-Concrete Composite Structures for Bridges, 2 ed.; China Communications Press: Beijing, 2017.
3. Deng, W. Discussion on the Causes of Diseases and Reinforcement Measures of Steel-Concrete Composite Girder Bridges. *People's Transportation* **2019**, 88+90.
4. Zeng, L. Experimental and Theoretical Studies on Reinforced Concrete Beams Strengthened with Prestressed CFRP Plates. Tongji University, 2005.
5. Huang, Y. Study on Maintenance Reinforcement Quality Inspection and Evaluation of Steel-Concrete Composite Bridges. *Urban Roads Bridges & Flood Control* **2013**, 175-179+111, doi:10.16799/j.cnki.csdqyfh.2013.06.053.
6. Ministry of Housing and Urban-Rural Development of China. JG/T 167—2016 Carbon Fiber Laminate for Strengthening and Restoring Structures. Standards Press of China: Beijing, 2016.
7. Deng, Q. Application of CFRP Prestressed Plate in Reinforced Concrete Bridge Reinforcement. *TranspoWorld* **2021**, 100-101+105, doi:10.16248/j.cnki.11-3723/u.2021.08.046.
8. Wan, S. Bridge with Prestressed CFRP Platesteel-Concrete Composite Beam Method Study on Strengthening of Experimental and Calculation. Ph.D, Southeast University, 2019.
9. Kianmofrad, F.; Ghafoori, E.; Elyasi, M.M.; Motavalli, M.; Rahimian, M. Strengthening of Metallic Beams with Different Types of Pre-stressed Un-bonded Retrofit Systems. *Composite Structures* **2017**, *159*, 81-95.

AUTHOR BIOGRAPHIES

	<p>Yin Shen, Born in Suzhou, Jiangsu Province, graduated from the Department of Bridges, Tongji University in 2022.</p> <p>Email: 1730727182@qq.com</p>		<p>Xuhong Qiang, Ph. D., Associate Professor, Department of Construction Engineering, School of Civil Engineering, Tongji University. Graduated from School of Civil and Geographical Engineering, Delft University of Technology, Delft, The Netherlands in 2013.</p> <p>Email: qiangxuhong@tongji.edu.cn</p>
---	--	---	---